

CND TEPPANYAKI GRILL COOK TOP SPECIFICATIONS
Size: L 31-1/2" x W 23-5/8" x H 1-5/8" (80 x 60 cm)

462 square inches HOT SPOT serves up to 8 people
Total cooking area ~685 sq/in incl. warming area
NOTE: WILL NOT FIT WITH STANDARD 24" CABINETS
INDOOR + OUTDOOR USE

Material: Professional Food Grade Best Alloy
German Stainless Steel type 304 (V2A)
5/32" thick (4 mm) cold pressed, hand-welded. Built-to-last. Silk-brushed finish.

Power: 1800 Watt | 1.8 kWh on #10
Electric: 115V | 50-60 Hz | 15 AMP
Warm-up time: 1.5 to 3 minutes
Cool-down time: 15 to 30 minutes

Analog temperature control:
1-10 dial | 2 indicator lights | thermostat
Contact Heat: 150°F to 430°F (65°-210°C)

5 Year Ltd. Warranty. Electrical + electronic parts: 1 year limited manufacturers'.
CE/ GS/ VDE approved. Electrical + electronic Components: UL approved.

OPTIONS:

- control box "A" for open mount + outdoors
- control box "B" for concealed interior mount

UPGRADES:

- ProStyle 2250 Watt | 230V only!
- Type 316 (V4A) stainless steel top
- Type 316 (V4A) stainless steel control box
- Type 304 or 316 heating element enclosure

Ship weight: 55 lbs. | ship size 37" x 31" x 7"
Ship weight: 25 kg | ship size 93 x 74 x 13 cm

PATENTED SHALLOW-DIP-TECHNOLOGY

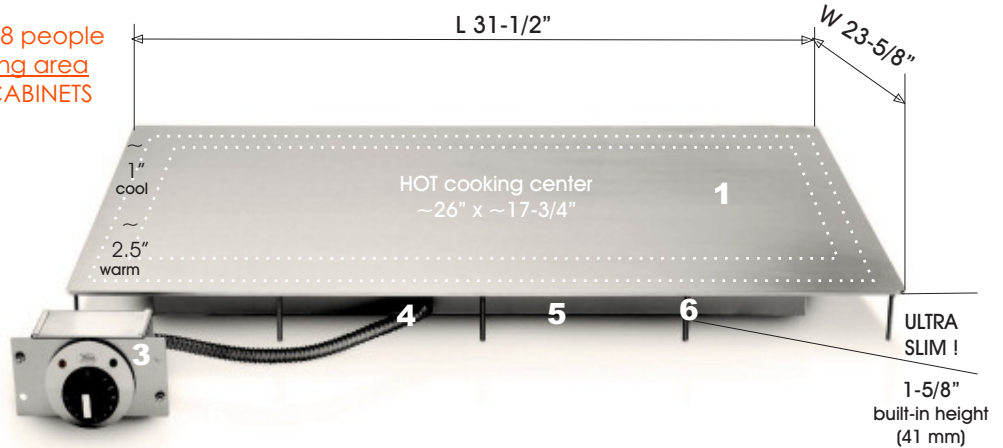

- 1 SOLID STAINLESS STEEL GRILL TOP
- 2 CONTROL BOX "A" for open under mount
- 3 CONTROL BOX "B" for concealed mounting
- 4 FLEXIBLE CONDUIT
- 5 SEALED HEATING ELEMENT ENCLOSURE
- 6 STAINLESS STEEL MOUNTING BOLTS 1-3/4" stainless steel washers & nuts included

10 FT. POWER CABLE, included
COOKING GUIDE, included



The manufacturer reserves the right to update, change, alter or discontinue any model without further notice.



SINCE 1887 - OVER 120 YEARS OF INNOVATION & PRECISION MANUFACTURING

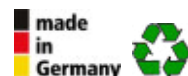

Stainless steel production uses 60-80% recycled raw material

Size: 800 mm x 600 mm x 41 mm H (31-1/2" x 23-5/8" x 1-5/8" height)

Rating: 115V /1800 Watt, 15 AMP, 50-60 Hz ,1.8 kWh on 10 (or 230V/1800 Watt, 8 AMP ▶▶ check control box label)

Bolts are 1-3/4 inch (45 mm) long; bolt diameter is 3/16"Ø (5 mm) ▶▶ drill 9/32"Ø (7 mm)!!!

IMPORTANT: DO NOT DRILL ANY HOLES BEFORE UNIT IS PHYSICALLY PRESENT! DO NOT CUT OFF THE BOLTS!

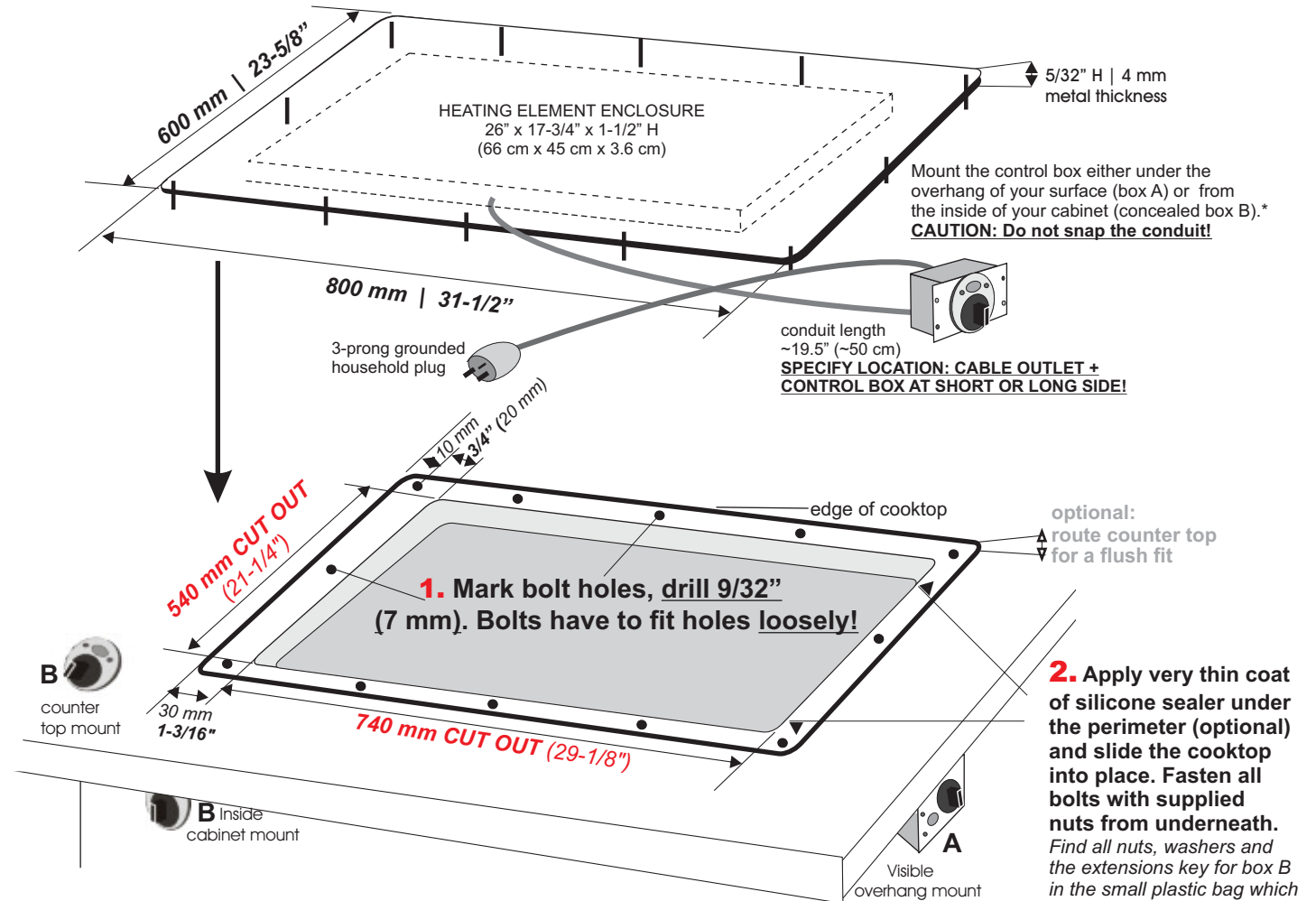

▶▶ CAUTION: DO NOT SNAP, PULL or TWIST THE CONDUIT DURING INSTALLATION !!!
Warranty will expire if capillary tube inside the conduit is damaged during installation.
Control box must be firmly fastened to a non-moving surface.

Note: drawing is not to scale

3. Mark, drill and fasten the control box into place. Now connect the power cable to the rear of the control box and plug the other end into a properly grounded household power outlet with correct voltage. Check label on the control box!

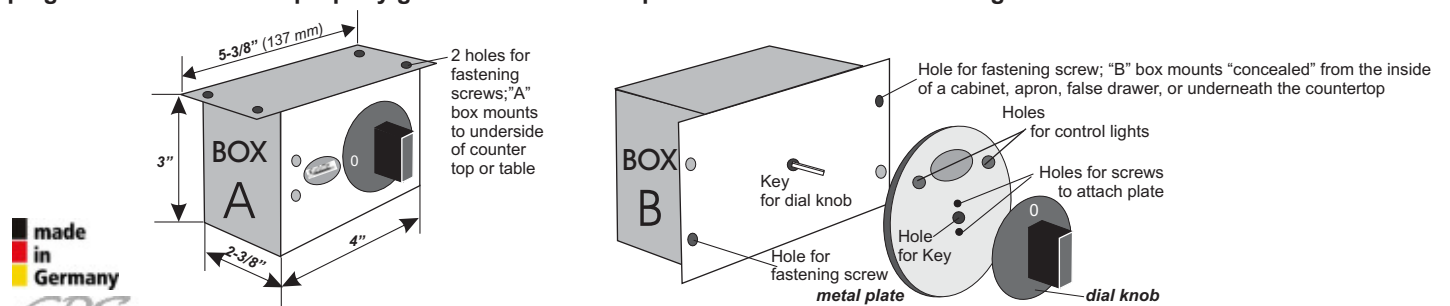

* ▶▶ **SPECIFY WHEN ORDERING:**

if you plan box A) open counter or table mount, or box B) concealed mounting ▶▶ see separate install sheet for Box B

BOLT HOLE DETAIL

Bolts are 1-3/4 inch (45 mm) long; bolt diameter is 3/16"Ø (5 mm) ▶▶ drill 9/32"Ø (7 mm)!!!

VERY IMPORTANT:
DO NOT CUT OR DRILL ANY HOLES BEFORE UNIT IS PHYSICALLY PRESENT. DO NOT CUT OFF THE BOLTS/STUDS!

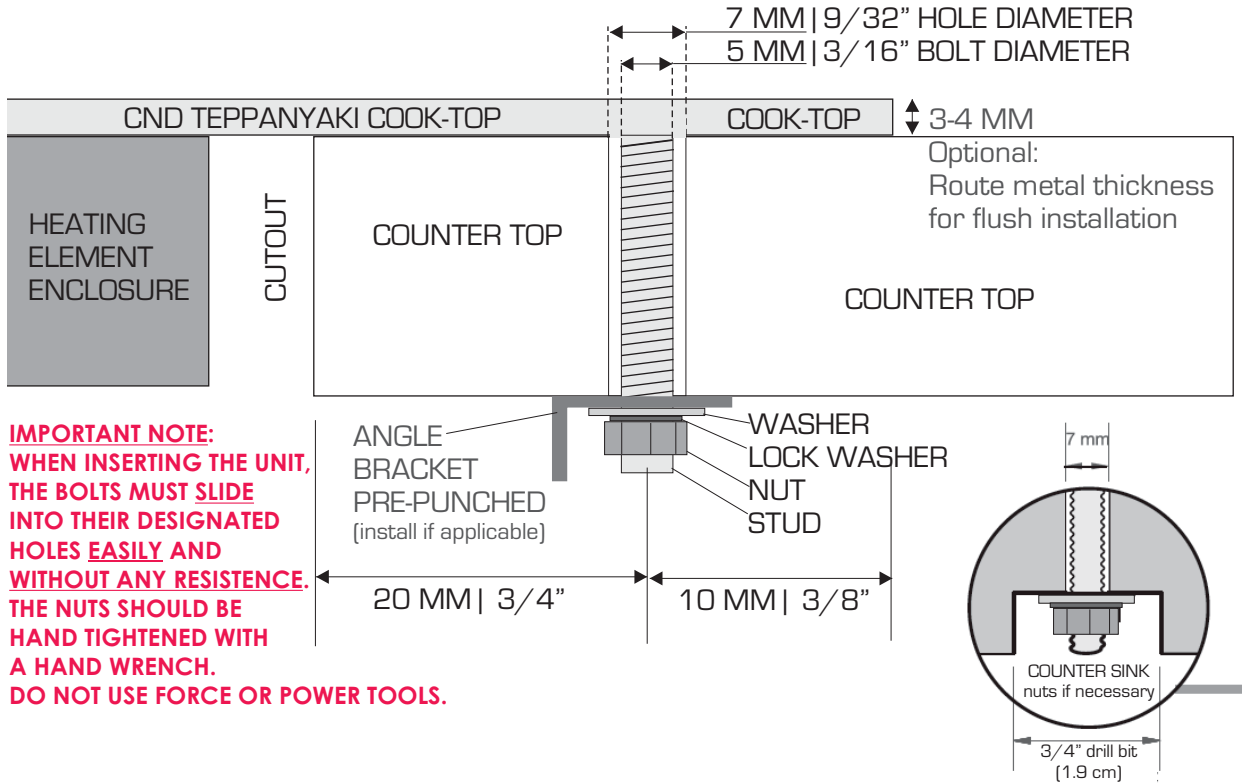

IMPORTANT NOTE:
WHEN INSERTING THE UNIT, THE BOLTS MUST SLIDE INTO THEIR DESIGNATED HOLES EASILY AND WITHOUT ANY RESISTANCE. THE NUTS SHOULD BE HAND TIGHTENED WITH A HAND WRENCH. DO NOT USE FORCE OR POWER TOOLS.

➤ **ATTENTION!!! MUST READ: INSTALLATION INTO STONE COUNTER TOPS**

Please be reminded that the stainless steel grill surface will flex slightly when switched on. This motion is intended and is counteracted by the bolts, which hold the unit in place.

If you intend to install into a stone counter-top, please talk to your counter top supplier/installer about your plans. A stone professional will be able to advise you on any aspects to watch out for, e.g. on how much counter-top "meat" is needed at the narrowest point to accommodate and secure a Cook-N-Dine built-in properly. For porous or "brittle" stone RODDING is a professional business practice which reinforces the narrow strips of material whenever a large cutout is made (e.g. for sinks, stoves, cook tops). This will support and strengthen those areas and shall prevent potential damage.

Alternatively, installers need to consider using angle brackets (order separately) along the full length of the cutout (both long sides), insert and then fasten the unit through those brackets. That way any stress applied to the counter material should be evenly distributed.

Note: Make sure to have the unit and all install sheets on site for counter top templating.

▶▶ **CAUTION: DO NOT SNAP, PULL or TWIST THE CONDUIT DURING INSTALLATION !!!**
Warranty will expire if capillary tube inside the conduit is damaged during installation.
Control box must be firmly fastened to a non-moving surface.

▶ CAUTION: DO NOT SNAP, PULL or TWIST THE CONDUIT DURING INSTALLATION !!!
Warranty will expire if capillary tube inside the conduit is damaged during installation.
Control box must be firmly fastened to a non-moving surface.

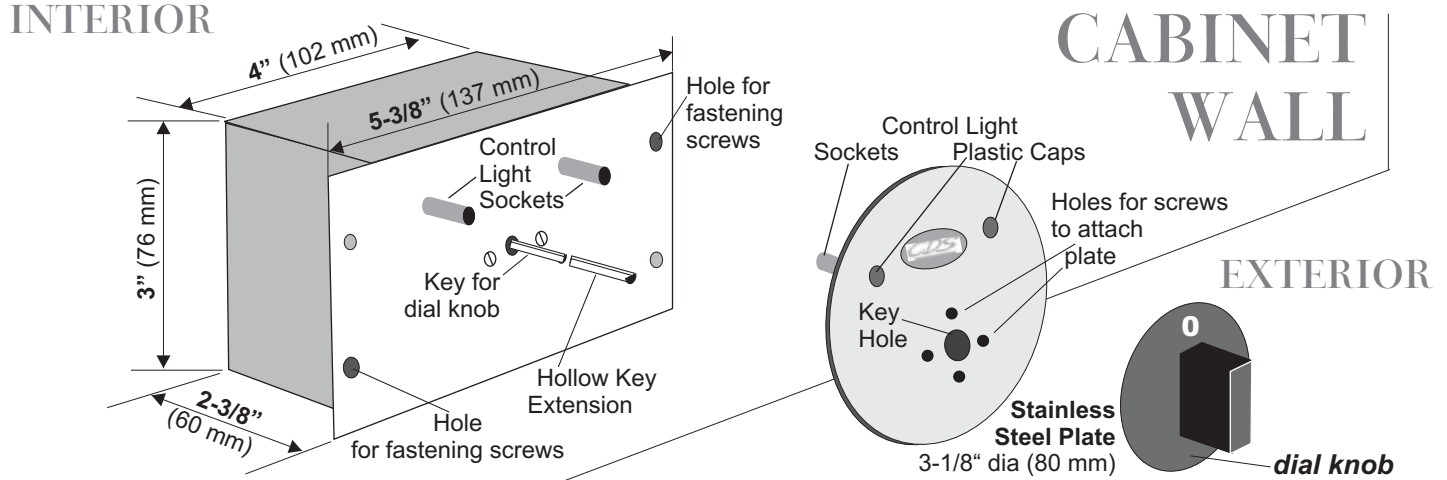

DIRECTIONS: **» VERY IMPORTANT NOTE: Do not open up the control box or will warranty expire!**

1. Remove packaging and carefully pull off the DIAL KNOB ONLY. Do not use force!
2. Unplug both control light caps from their sockets by wiggling the steel plate away including the yellow and green plastic caps (Hold socket with two fingers and gently pull plate away from sockets; Yellow and green CAPS STAY IN PLACE in the plate.)
3. Mark all necessary holes utilizing the provided template below. Drill holes and fasten box to the inside of cabinet with 2 screws.
4. Carefully pull light sockets out a bit and re-connect with casings. Slide decorative plate into place; affix with two small flathead screws. ALTERNATIVELY, E. G. FOR GRANITE SURFACES, YOU CAN AFFIX THE PLATE WITH SILICONE ADHESIVE.
5. Connect the stem extension to stem if needed (packed with the nuts + washers). Slide dial knob onto stem (match flat side of stem with flat side of centered receptacle at back of knob). Do not use force. The "0" has to be aligned below the center of CDS logo.

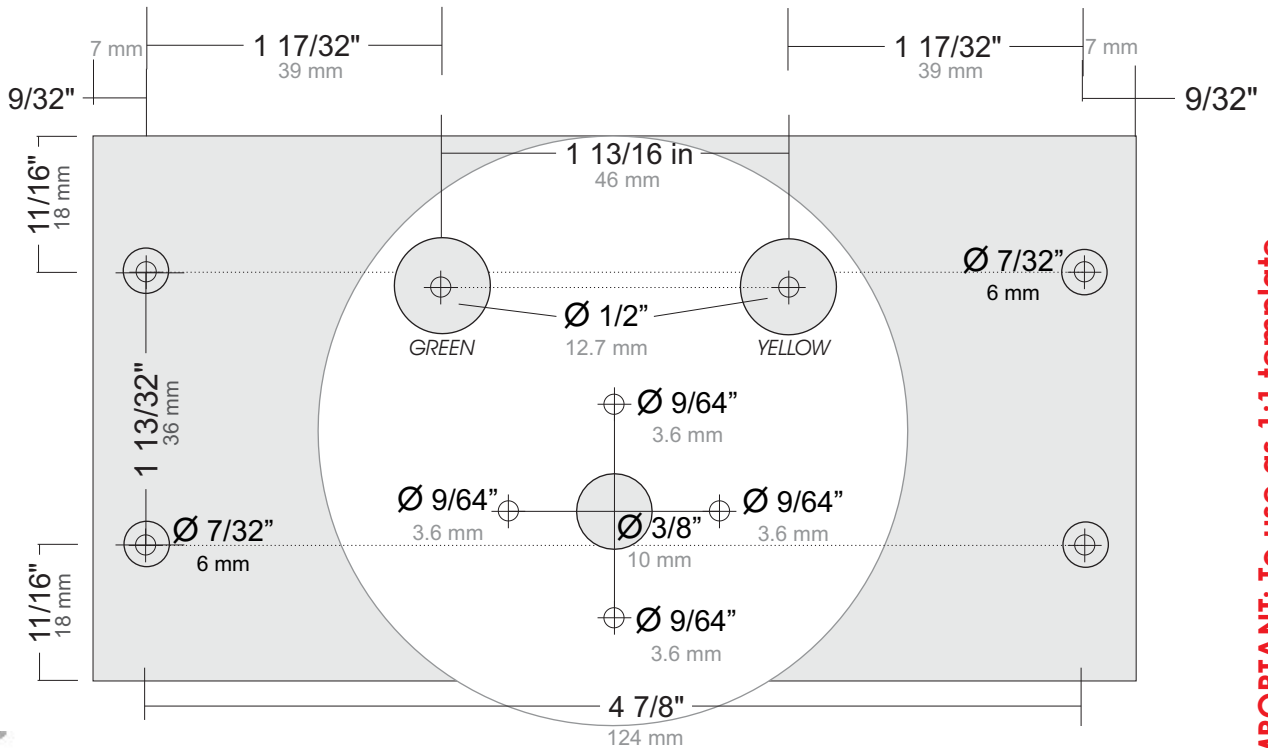

IMPORTANT: To use as 1:1 template set "page scaling" to "none" when printing